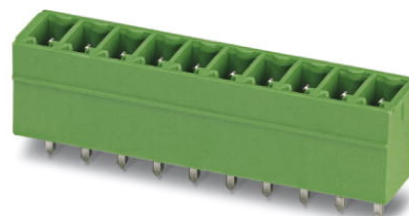

MCV 1,5/ 5-G-3,81

Order No.: 1803455

The figure shows a 10-position version of the product

<http://eshop.phoenixcontact.de/phoenix/treeViewClick.do?UID=1803455>Header, nominal current: 8 A, rated voltage: 160 V, pitch: 3.81 mm, no.
of positions: 5, mounting: Soldering

Commercial data	
EAN	4017918045760
Pack	50 Pcs.
Customs tariff	85366990
Weight/Piece	0.001653 KG
Catalog page information	Page 153 (CC-2007)

Product notesWEEE/RoHS-compliant since:
01/01/2003

<http://www.download.phoenixcontact.com>
Please note that the data given here has been taken from the online catalog. For comprehensive information and data, please refer to the user documentation. The General Terms and Conditions of Use apply to Internet downloads.

Technical data**Dimensions / positions**

Pitch	3.81 mm
Dimension a	15.24 mm
Number of positions	5
Pin dimensions	0,8 x 0,8 mm
Hole diameter	1.2 mm

Technical data

Insulating material group	IIIa
Rated surge voltage (III/3)	2.5 kV
Rated surge voltage (III/2)	2.5 kV
Rated surge voltage (II/2)	2.5 kV
Rated voltage (III/2)	160 V
Rated voltage (II/2)	250 V
Connection in acc. with standard	EN-VDE
Nominal current I_N	8 A
Nominal voltage U_N	160 V
Maximum load current	8 A
Insulating material	PBT
Inflammability class acc. to UL 94	V0

Certificates / Approvals



CSA

Nominal voltage U_N	300 V
Nominal current I_N	8 A

CUL

Nominal voltage U_N	300 V
Nominal current I_N	8 A

UL

Nominal voltage U_N	300 V
Nominal current I_N	8 A
Certification	CB, CSA, CUL, GOST, UL, VDE-PZI

Accessories

Item	Designation	Description
------	-------------	-------------

Marking

1051993	B-STIFT	Marker pen, for manual labeling of unprinted Zack strips, smear-proof and waterproof, line thickness 0.5 mm
---------	---------	---

0804109	SK 3,81/2,8:FORTL.ZAHLEN	Marker card, printed horizontally, self-adhesive, 10-section marker strip, 14 identical decades marked 1-10, 11-20 etc. up to 91-(99)100, sufficient for 140 terminal blocks
0805056	SK 3,81/2,8:SO	Marker card, special printing, self-adhesive, labeled acc. to customer requirements, 14 identical marker strips per card, max. 25-position labeling per strip, color: White

Plug/Adapter

1734634	CP-MSTB	Coding profile, is inserted into the slot on the plug or inverted header, red insulating material
---------	---------	---

Additional products

Item	Designation	Description
General		
1851070	FK-MCP 1,5/ 5-ST-3,81	Plug component, nominal current: 8 A, rated voltage: 160 V, pitch: 3.81 mm, no. of positions: 5, type of connection: Spring-cage connection
1850699	FRONT-MC 1,5/ 5-ST-3,81	Plug component, nominal current: 8 A, rated voltage: 160 V, pitch: 3.81 mm, no. of positions: 5, type of connection: Screw connection
1862603	IMC 1,5/ 5-G-3,81	Header, nominal current: 8 A, rated voltage: 160 V, pitch: 3.81 mm, no. of positions: 5, mounting: Soldering
1875454	IMCV 1,5/ 5-G-3,81	Header, nominal current: 8 A, rated voltage: 160 V, pitch: 3.81 mm, no. of positions: 5, mounting: Soldering
1803604	MC 1,5/ 5-ST-3,81	Plug component, nominal current: 8 A, rated voltage: 160 V, pitch: 3.81 mm, no. of positions: 5, type of connection: Screw connection
1852202	MCC 1/ 5-STZ-3,81	Plug component, nominal current: 8 A, rated voltage: 160 V, pitch: 3.81 mm, no. of positions: 5, type of connection: Crimp connection
1827156	MCVR 1,5/ 5-ST-3,81	Plug component, nominal current: 8 A, rated voltage: 160 V, pitch: 3.81 mm, no. of positions: 5, type of connection: Screw connection
1827004	MCVW 1,5/ 5-ST-3,81	Plug component, nominal current: 8 A, rated voltage: 160 V, pitch: 3.81 mm, no. of positions: 5, type of connection: Screw connection
1897429	QC 0,5/ 5-ST-3,81	Plug, nominal current: 6 A, rated voltage: 320 V, pitch: 3.81 mm, number of positions: 5, connection method: Insulation displacement connection QUICKON

Drawings

Drilling diagram

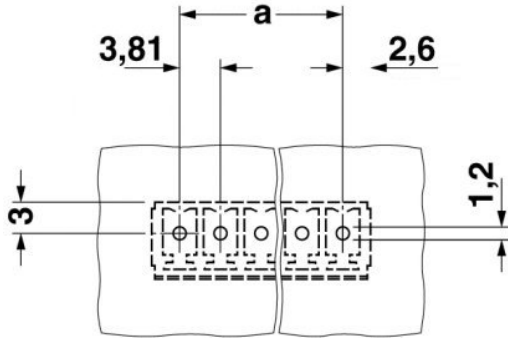

Diagram

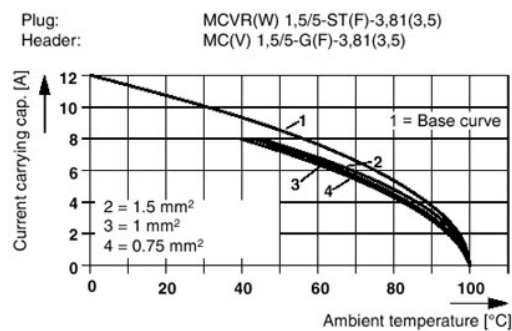
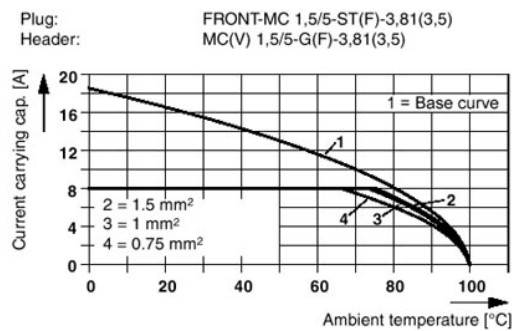
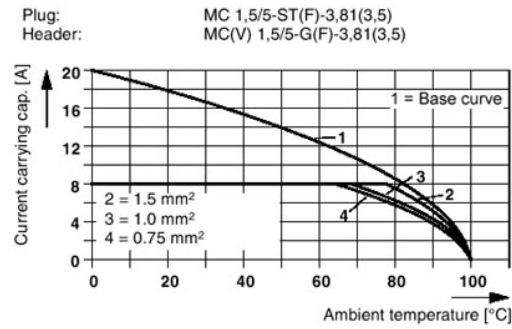
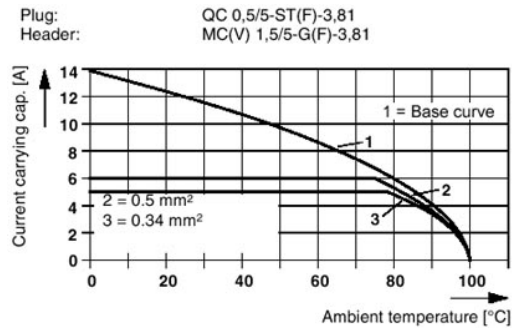
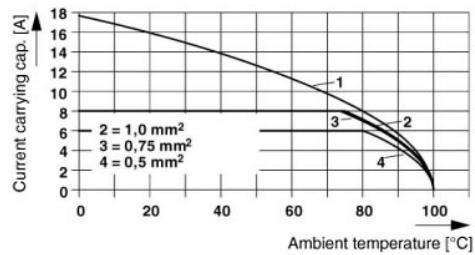
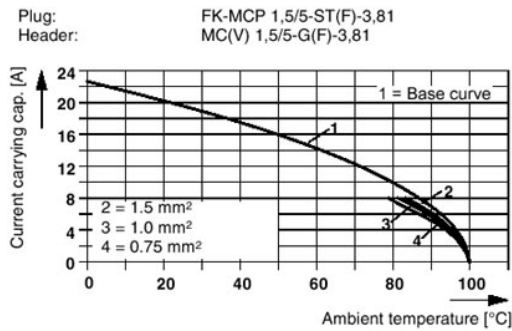

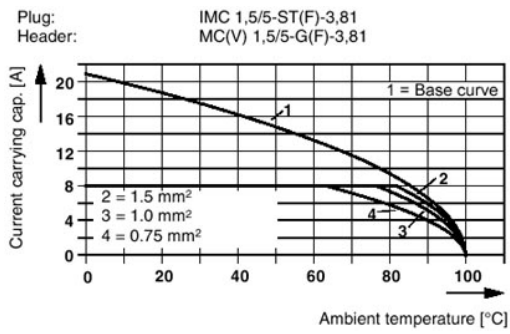

Dimensioned drawing

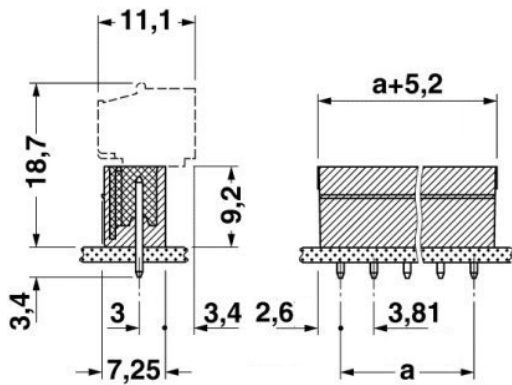

Address

PHOENIX CONTACT GmbH & Co. KG
Flachsmarktstr. 8
32825 Blomberg, Germany
Phone +49 5235 3 00
Fax +49 5235 3 41200
<http://www.phoenixcontact.de>



© 2008 Phoenix Contact
Technical modifications reserved;